

MDD1902

Single N-channel Trench MOSFET 100V, 40A, 28mΩ

General Description

The MDD1902 uses advanced MagnaChip's MOSFET Technology, which provides high performance in on-state resistance, fast switching performance and excellent quality. MDD1902 is suitable device for DC/DC Converters and general purpose applications.

Features

- $V_{DS} = 100V$
- $I_D = 40A$ @ $V_{GS} = 10V$
- $R_{DS(ON)}$
 $< 28m\Omega$ @ $V_{GS} = 10V$
 $< 31m\Omega$ @ $V_{GS} = 6.0V$

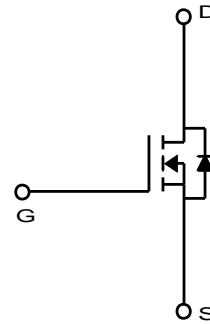
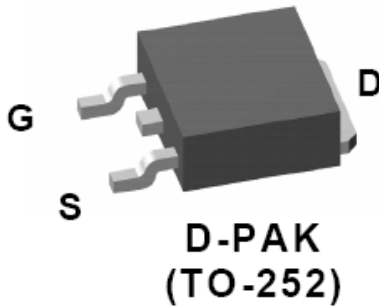

Absolute Maximum Ratings (Tc = 25°C)

Characteristics		Symbol	Rating	Unit
Drain-Source Voltage		V_{DSS}	100	V
Gate-Source Voltage		V_{GSS}	±20	V
Continuous Drain Current ⁽¹⁾	$T_C=25^\circ C$	I_D	40	A
	$T_C=100^\circ C$		25	A
Pulsed Drain Current		I_{DM}	80	A
Power Dissipation	$T_C=25^\circ C$	P_D	83	W
	$T_C=100^\circ C$		33	
Single Pulse Avalanche Energy ⁽²⁾		E_{AS}	200	mJ
Junction and Storage Temperature Range		T_J, T_{stg}	-55~150	°C

Thermal Characteristics

Characteristics	Symbol	Rating	Unit
Thermal Resistance, Junction-to-Ambient	$R_{\theta JA}$	50	°C/W
Thermal Resistance, Junction-to-Case ⁽¹⁾	$R_{\theta JC}$	1.5	

Ordering Information

Part Number	Temp. Range	Package	Packing	Rohs Status
MDD1902RH	-55~150°C	D-PAK	Tape & Reel	Halogen Free

Electrical Characteristics (Tc =25°C)

Characteristics	Symbol	Test Condition	Min	Typ	Max	Unit
Static Characteristics						
Drain-Source Breakdown Voltage	BV_{DSS}	$I_D = 250\mu A, V_{GS} = 0V$	100	-	-	V
Gate Threshold Voltage	$V_{GS(th)}$	$V_{DS} = V_{GS}, I_D = 250\mu A$	2.0	3.0	4.0	
Drain Cut-Off Current	I_{DSS}	$V_{DS} = 80V, V_{GS} = 0V$	-	-	1	μA
Gate Leakage Current	I_{GSS}	$V_{GS} = \pm 20V, V_{DS} = 0V$	-	-	± 0.1	
Drain-Source ON Resistance	$R_{DS(on)}$	$V_{GS} = 10V, I_D = 20A$	-	21	28	m Ω
		$T_J = 125^\circ C$	-	32	40	
		$V_{GS} = 6.0V, I_D = 20A$	-	23.5	31	
Forward Transconductance	g_{fs}	$V_{DS} = 5V, I_D = 20A$	-	55	-	S
Dynamic Characteristics						
Total Gate Charge	Q_g	$V_{DS} = 50V, I_D = 20A, V_{GS} = 10V$	-	39.8	48	nC
Gate-Source Charge	Q_{gs}		-	11	-	
Gate-Drain Charge	Q_{gd}		-	11.2	-	
Input Capacitance	C_{iss}	$V_{DS} = 25V, V_{GS} = 0V, f = 1.0MHz$	-	2087	2505	pF
Reverse Transfer Capacitance	C_{riss}		-	82	-	
Output Capacitance	C_{oss}		-	230	-	
Gate Resistance	R_g	$V_{GS}=0V, V_{DS}=0V, F=1MHz$	-	2.1	2.5	Ω
Turn-On Delay Time	$t_{d(on)}$	$V_{DS}=50V, V_{GS}=10V, R_L=3.2\Omega, R_{GEN}=3.2\Omega$	-	10.5		ns
Rise Time	t_r		-	27.5		
Turn-Off Delay Time	$t_{d(off)}$		-	38.5		
Fall Time	t_f		-	14		
Drain-Source Body Diode Characteristics						
Source-Drain Diode Forward Voltage	V_{SD}	$I_S = 1A, V_{GS} = 0V$	-	0.7	1.2	V
Body Diode Reverse Recovery Time	t_{rr}	$I_F = 20A, di/dt = 100A/\mu s$	-	63	76	ns
Body Diode Reverse Recovery Charge	Q_{rr}		-	145	-	nC

Note :

1. Surface mounted RF4 board with 2oz. Copper.
2. Starting $T_J=25^\circ C, L=1mH, I_{AS}=20A, V_{DD}=50V, V_{GS}=10V$

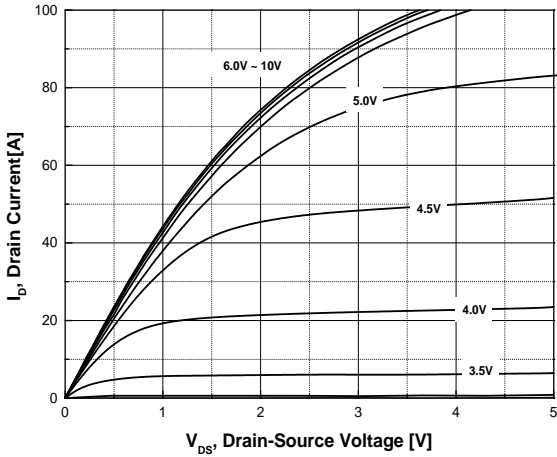

Fig.1 On-Region Characteristics

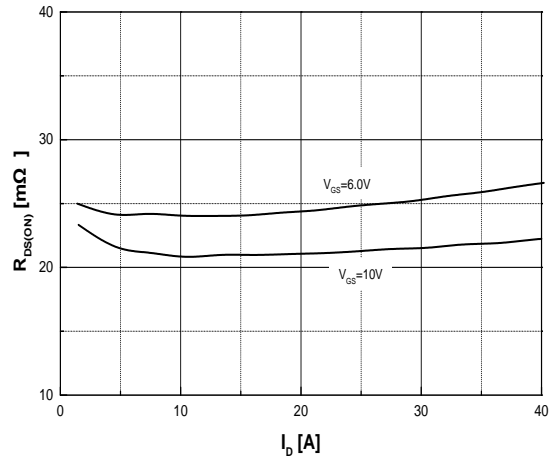

Fig.2 On-Resistance Variation with Drain Current and Gate Voltage

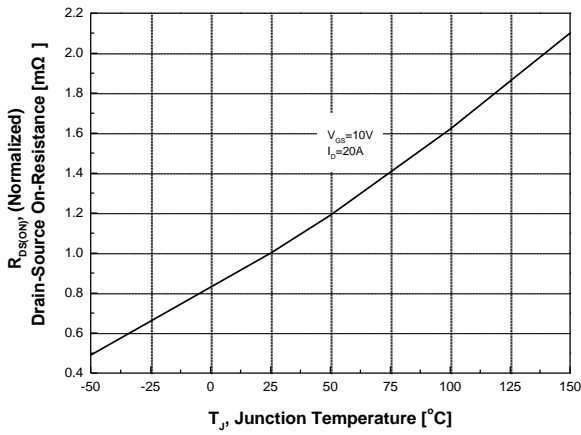

Fig.3 On-Resistance Variation with Temperature

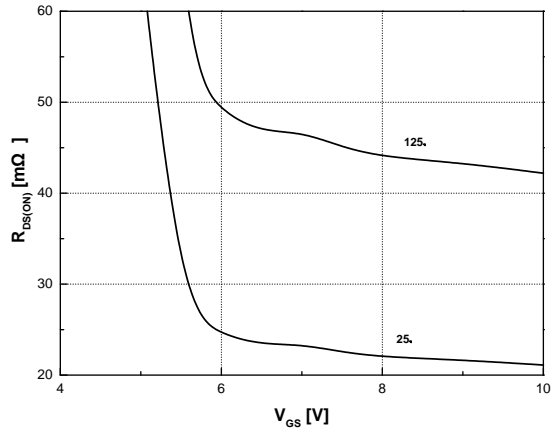

Fig.4 On-Resistance Variation with Gate to Source Voltage

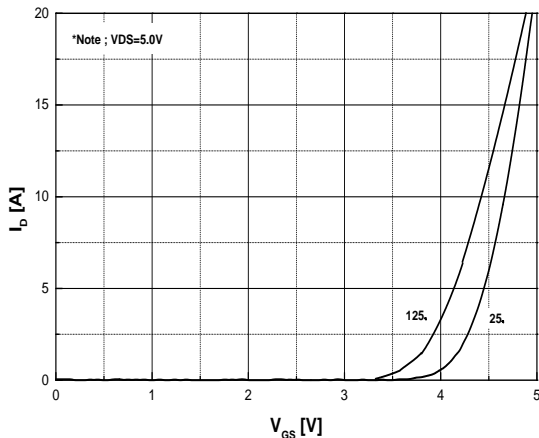

Fig.5 Transfer Characteristics

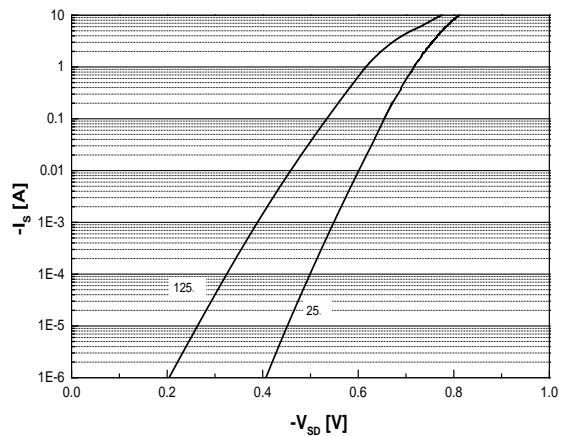

Fig.6 Body Diode Forward Voltage Variation with Source Current and Temperature

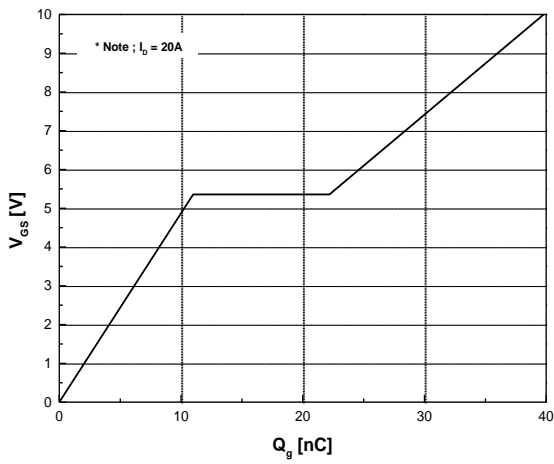

Fig.7 Gate Charge Characteristics

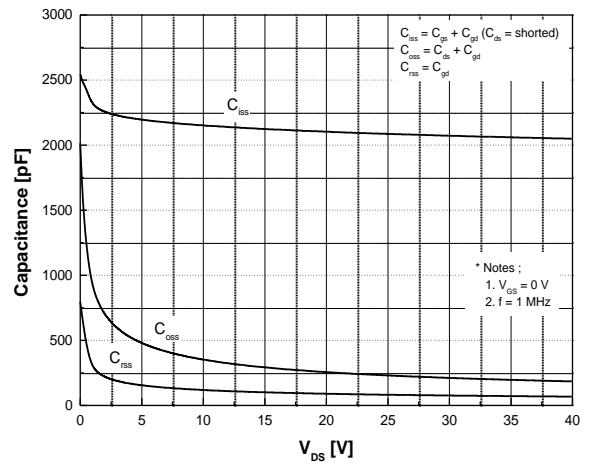

Fig.8 Capacitance Characteristics

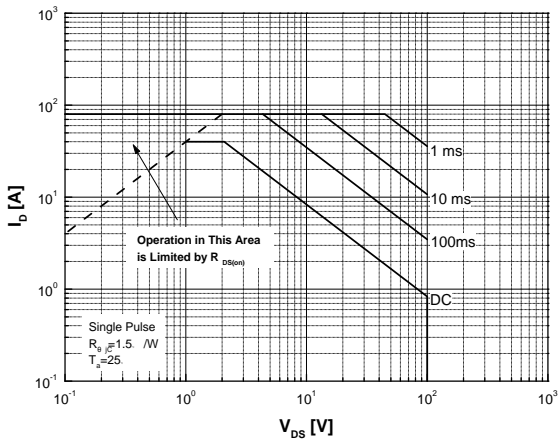

Fig.9 Maximum Safe Operating Area

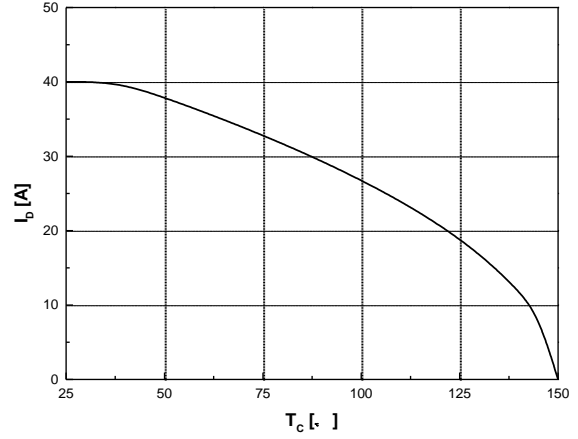

Fig.10 Maximum Drain Current vs. Case Temperature

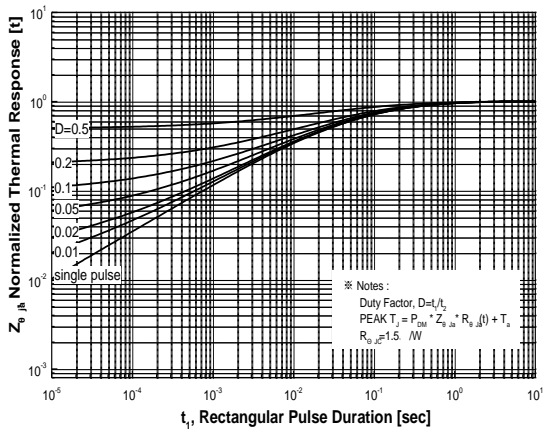
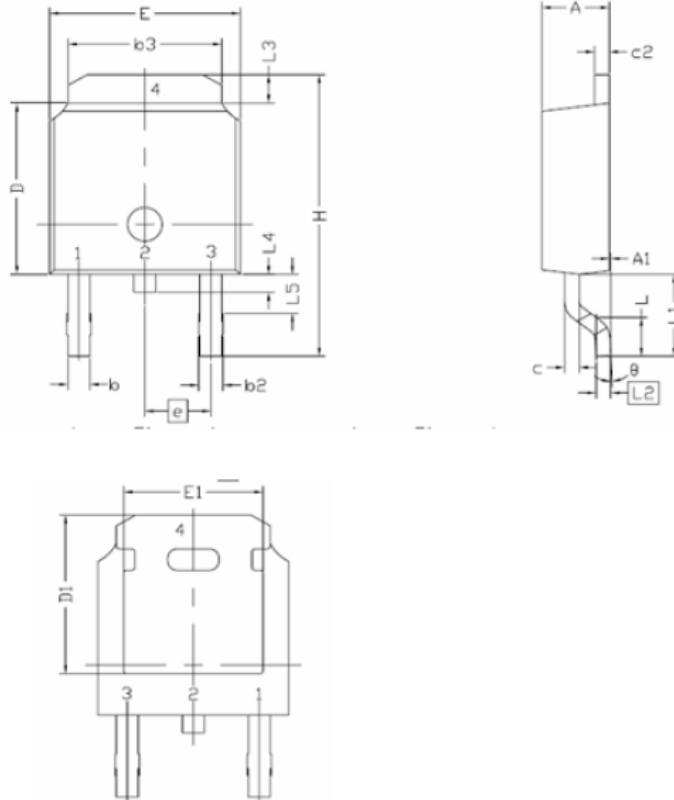

Fig.11 Transient Thermal Response Curve

Package Dimension

D-PAK (TO-252)

Dimensions are in millimeters, unless otherwise specified



Symbol	Min.	Nom.	Max.
E	6,35	-	6,73
L	1,40	1,52	1,78
L1	2,74 REF		
L2	0,508 BCS		
L3	0,89	-	1,27
L4	-	-	1,02
L5	1,14	-	1,52
D	5,97	6,10	6,22
H	9,40	-	10,41
b	0,64	-	0,89
b2	0,76	-	1,14
b3	4,95	-	5,46
e	2,286 BSC		
A	2,18	-	2,39
A1	-	-	0,13
c	0,46	-	0,61
c2	0,46	-	0,89
D1	5,21	-	-
E1	4,32	-	-
⌀	0,00	-	10,00

DISCLAIMER:

The Products are not designed for use in hostile environments, including, without limitation, aircraft, nuclear power generation, medical appliances, and devices or systems in which malfunction of any Product can reasonably be expected to result in a personal injury. Seller's customers using or selling Seller's products for use in such applications do so at their own risk and agree to fully defend and indemnify Seller.

MagnaChip reserves the right to change the specifications and circuitry without notice at any time. MagnaChip does not consider responsibility for use of any circuitry other than circuitry entirely included in a MagnaChip product. [MagnaChip](#) is a registered trademark of MagnaChip Semiconductor Ltd.