

General Description

The MDD1903 uses advanced MagnaChip's MOSFET Technology, which provides high performance in on-state resistance, fast switching performance and excellent quality. MDD1903 is suitable device for DC to DC converter and general purpose applications.

Features

- $V_{DS} = 100V$
- $I_D = 12.8A @ V_{GS} = 10V$
- $R_{DS(ON) (MAX)} < 105m\Omega @ V_{GS} = 10V$
 $< 110m\Omega @ V_{GS} = 6.0V$

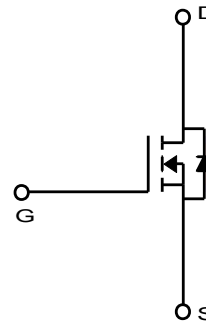
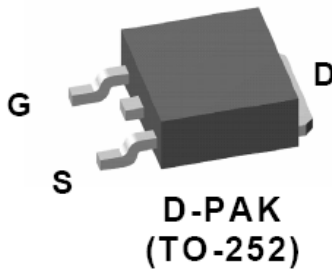

Absolute Maximum Ratings (Tc = 25°C)

| Characteristics | | Symbol | Rating | Unit |
|--|------------------|----------------|---------|------|
| Drain-Source Voltage | | V_{DSS} | 100 | V |
| Gate-Source Voltage | | V_{GSS} | ±20 | V |
| Continuous Drain Current ⁽¹⁾ | $T_C=25^\circ C$ | I_D | 12.8 | A |
| | $T_C=70^\circ C$ | | 10.3 | |
| Pulsed Drain Current | | I_{DM} | 40 | A |
| Power Dissipation | $T_C=25^\circ C$ | P_D | 36.8 | W |
| | $T_C=70^\circ C$ | | 23.6 | |
| Single Pulse Avalanche Energy ⁽²⁾ | | E_{AS} | 21 | mJ |
| Junction and Storage Temperature Range | | T_J, T_{stg} | -55~150 | °C |

Thermal Characteristics

| Characteristics | Symbol | Rating | Unit |
|--|-----------------|--------|------|
| Thermal Resistance, Junction-to-Ambient ⁽¹⁾ | $R_{\theta JA}$ | 52 | °C/W |
| Thermal Resistance, Junction-to-Case | $R_{\theta JC}$ | 3.4 | |

Ordering Information

| Part Number | Temp. Range | Package | Packing | Rohs Status |
|-------------|-------------|---------|-------------|--------------|
| MDD1903RH | -55~150°C | D-PAK | Tape & Reel | Halogen Free |

Electrical Characteristics (T_J =25°C)

| Characteristics | Symbol | Test Condition | Min | Typ | Max | Unit |
|--|--------------|--|-----|------|-----------|------------|
| Static Characteristics | | | | | | |
| Drain-Source Breakdown Voltage | BV_{DSS} | $I_D = 250\mu A, V_{GS} = 0V$ | 100 | - | - | V |
| Gate Threshold Voltage | $V_{GS(th)}$ | $V_{DS} = V_{GS}, I_D = 250\mu A$ | 1.0 | 2.0 | 3.0 | |
| Drain Cut-Off Current | I_{DSS} | $V_{DS} = 80V, V_{GS} = 0V$ | - | - | 1 | μA |
| Gate Leakage Current | I_{GSS} | $V_{GS} = \pm 20V, V_{DS} = 0V$ | - | - | ± 0.1 | |
| Drain-Source ON Resistance | $R_{DS(on)}$ | $V_{GS} = 10V, I_D = 10A$ | - | 85 | 105 | m Ω |
| | | $V_{GS} = 6.0V, I_D = 10A$ | - | 90 | 110 | |
| Forward Transconductance | g_{fs} | $V_{DS} = 10V, I_D = 10A$ | - | 17 | - | S |
| Dynamic Characteristics | | | | | | |
| Total Gate Charge | $Q_{g(10V)}$ | $V_{DS} = 50.0V, I_D = 10A, V_{GS} = 10V$ | - | 8.8 | - | nC |
| Gate-Source Charge | Q_{gs} | | - | 1.7 | - | |
| Gate-Drain Charge | Q_{gd} | | - | 2.3 | - | |
| Input Capacitance | C_{iss} | $V_{DS} = 25.0V, V_{GS} = 0V, f = 1.0MHz$ | - | 475 | 800 | pF |
| Reverse Transfer Capacitance | C_{riss} | | - | 20 | - | |
| Output Capacitance | C_{oss} | | - | 60 | - | |
| Turn-On Delay Time | $t_{d(on)}$ | $V_{GS} = 10V, V_{DS} = 50V, I_D = 10A, R_G = 3.0\Omega$ | - | 6.8 | - | ns |
| Rise Time | t_r | | - | 10.6 | - | |
| Turn-Off Delay Time | $t_{d(off)}$ | | - | 16.2 | - | |
| Fall Time | t_f | | - | 5.5 | - | |
| Drain-Source Body Diode Characteristics | | | | | | |
| Source-Drain Diode Forward Voltage | V_{SD} | $I_S = 10A, V_{GS} = 0V$ | - | 0.75 | 1.2 | V |
| Body Diode Reverse Recovery Time | t_{rr} | $I_F = 10A, di/dt = 100A/\mu s$ | - | 42.0 | - | ns |
| Body Diode Reverse Recovery Charge | Q_{rr} | | - | 69.0 | - | nC |

Note :

- Surface mounted FR-4 board by JEDEC (jesd51-7)
- E_{AS} is tested at starting T_J = 25°C, L = 1.0mH, I_{AS} = 6.5A, V_{DD} = 50V, V_{GS} = 10V

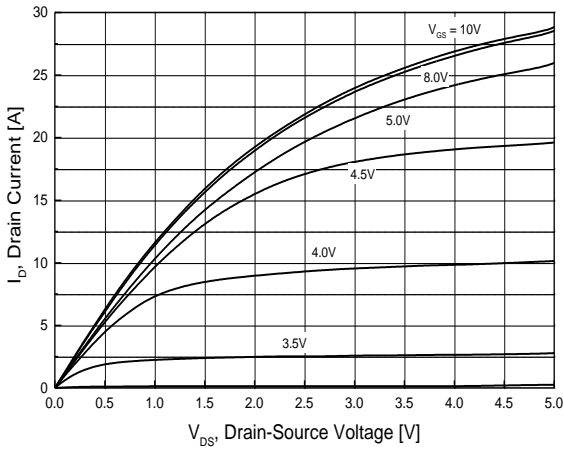

Fig.1 On-Region Characteristics

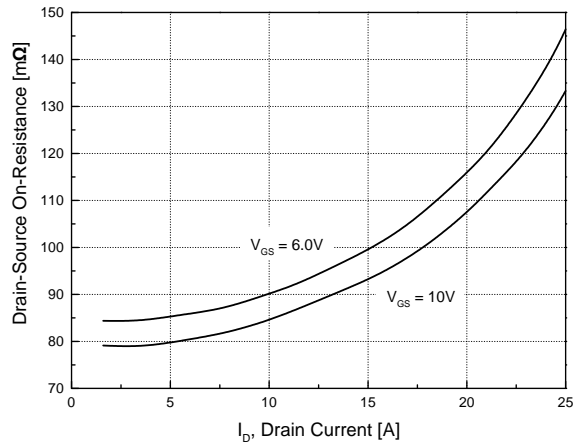

Fig.2 On-Resistance Variation with Drain Current and Gate Voltage

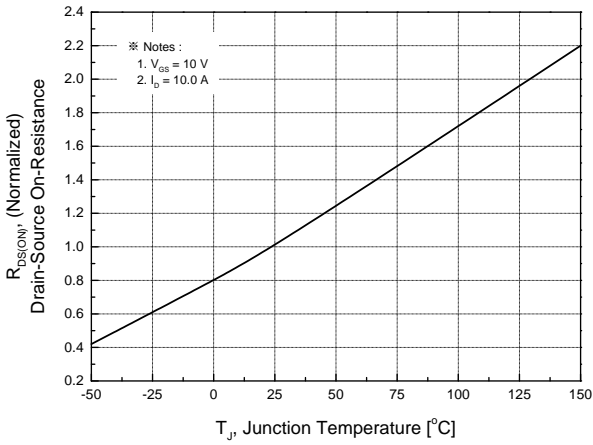

Fig.3 On-Resistance Variation with Temperature

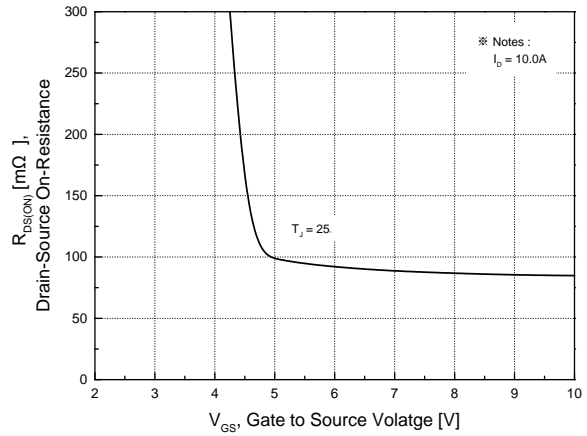

Fig.4 On-Resistance Variation with Gate to Source Voltage

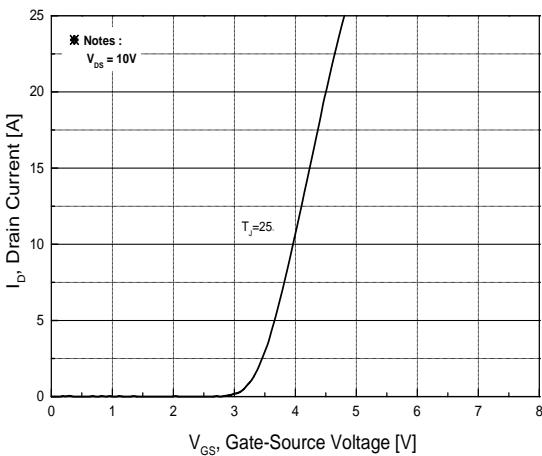

Fig.5 Transfer Characteristics

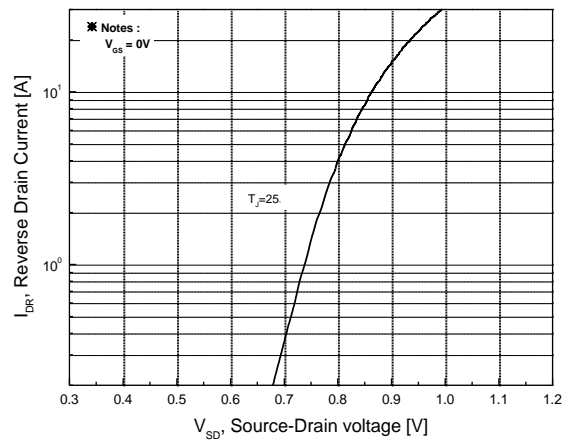

Fig.6 Body Diode Forward Voltage Variation with Source Current and Temperature

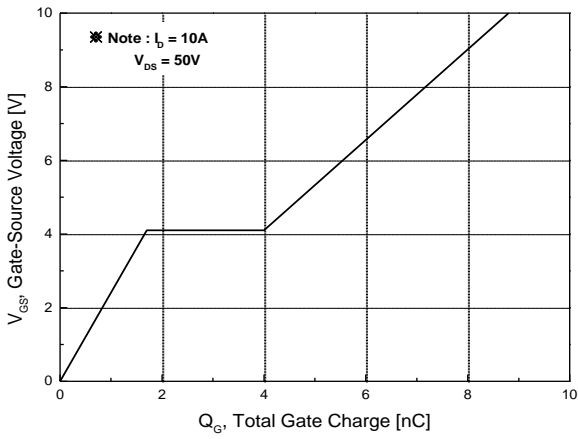

Fig.7 Gate Charge Characteristics

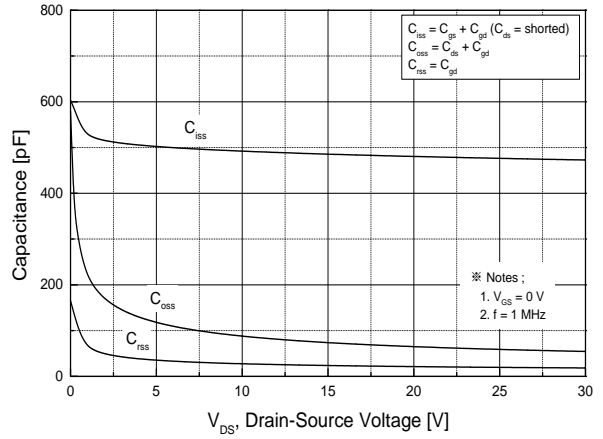

Fig.8 Capacitance Characteristics

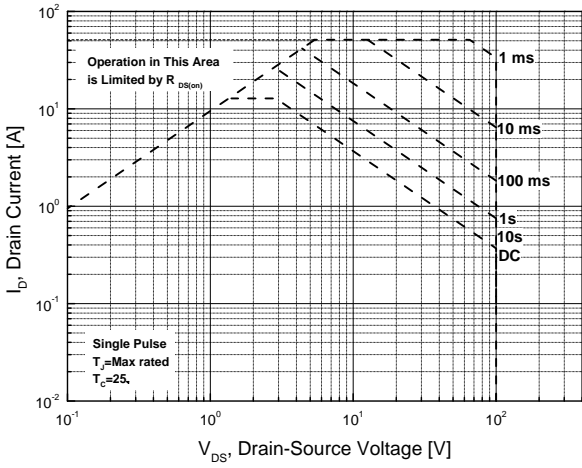

Fig.9 Maximum Safe Operating Area

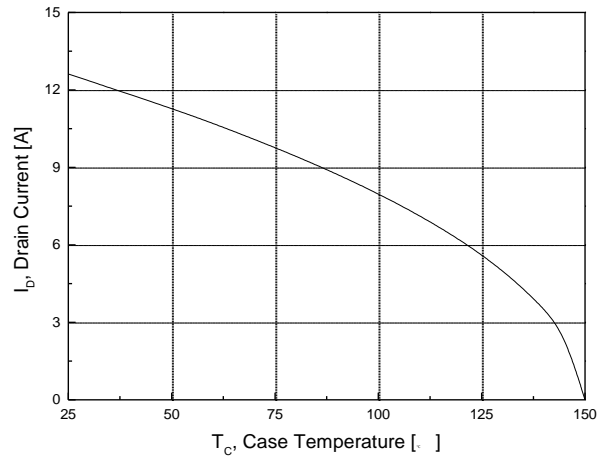

Fig.10 Maximum Drain Current vs. Case Temperature

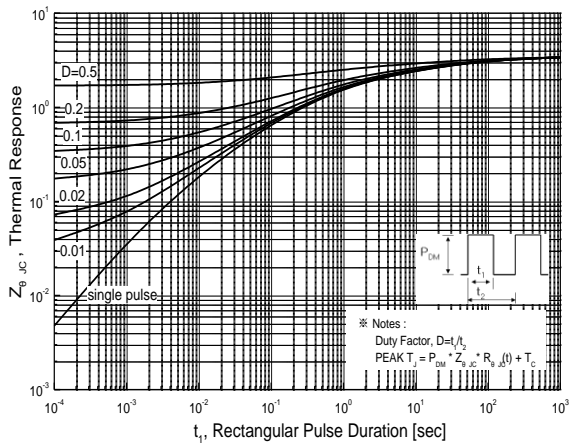
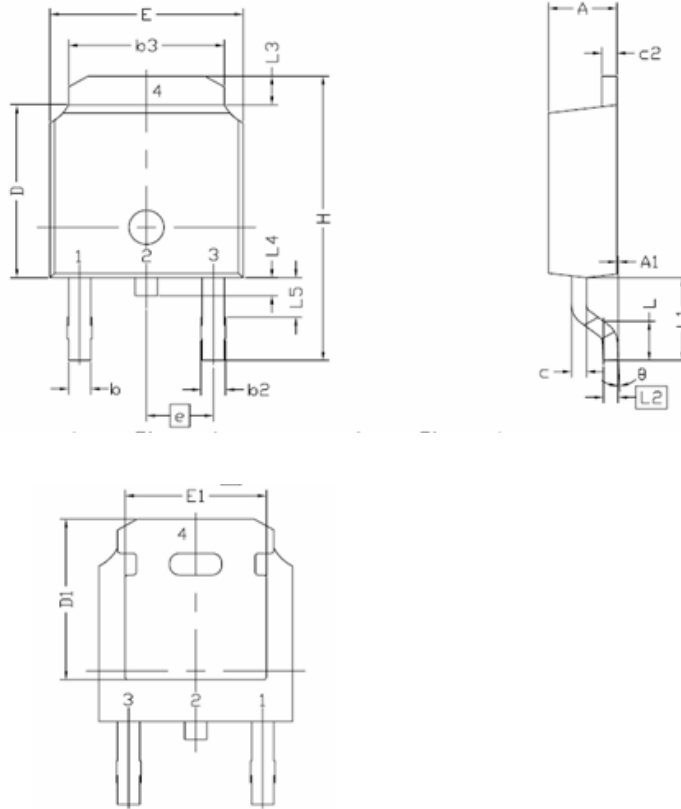

Fig.11 Transient Thermal Response Curve

Package Dimension

D-PAK (TO-252)

Dimensions are in millimeters, unless otherwise specified



| Symbol | Min. | Nom. | Max. |
|--------|-----------|------|-------|
| E | 6.35 | - | 6.73 |
| L | 1.40 | 1.52 | 1.78 |
| L1 | 2.74 REF | | |
| L2 | 0.508 BCS | | |
| L3 | 0.89 | - | 1.27 |
| L4 | - | - | 1.02 |
| L5 | 1.14 | - | 1.52 |
| D | 5.97 | 6.10 | 6.22 |
| H | 9.40 | - | 10.41 |
| b | 0.64 | - | 0.89 |
| b2 | 0.76 | - | 1.14 |
| b3 | 4.95 | - | 5.46 |
| e | 2.286 BSC | | |
| A | 2.18 | - | 2.39 |
| A1 | - | - | 0.13 |
| c | 0.46 | - | 0.61 |
| c2 | 0.46 | - | 0.89 |
| D1 | 5.21 | - | - |
| E1 | 4.32 | - | - |
| ⌀ | 0.00 | - | 10.00 |

DISCLAIMER:

The Products are not designed for use in hostile environments, including, without limitation, aircraft, nuclear power generation, medical appliances, and devices or systems in which malfunction of any Product can reasonably be expected to result in a personal injury. Seller's customers using or selling Seller's products for use in such applications do so at their own risk and agree to fully defend and indemnify Seller.

MagnaChip reserves the right to change the specifications and circuitry without notice at any time. MagnaChip does not consider responsibility for use of any circuitry other than circuitry entirely included in a MagnaChip product. [MagnaChip](#) is a registered trademark of MagnaChip Semiconductor Ltd.